

Verpackt im Gurt nach DIN IEC 60286-3
 Tape on Reel Packaging according to DIN IEC 60286-3
 Verpackungseinheit: 280 Stück
 Packaging unit: 280 pcs

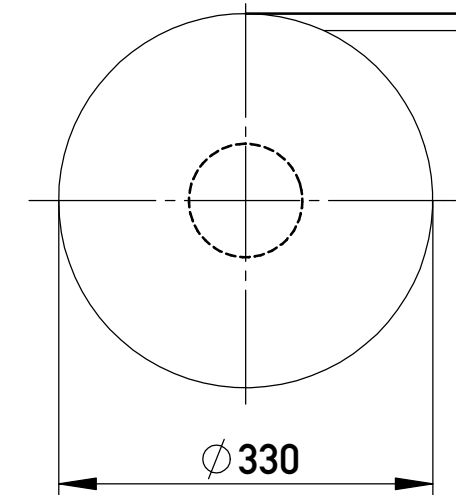

Abspulrichtung - Reel off Direction

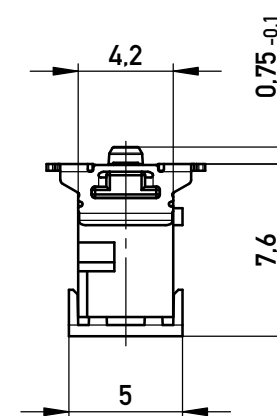
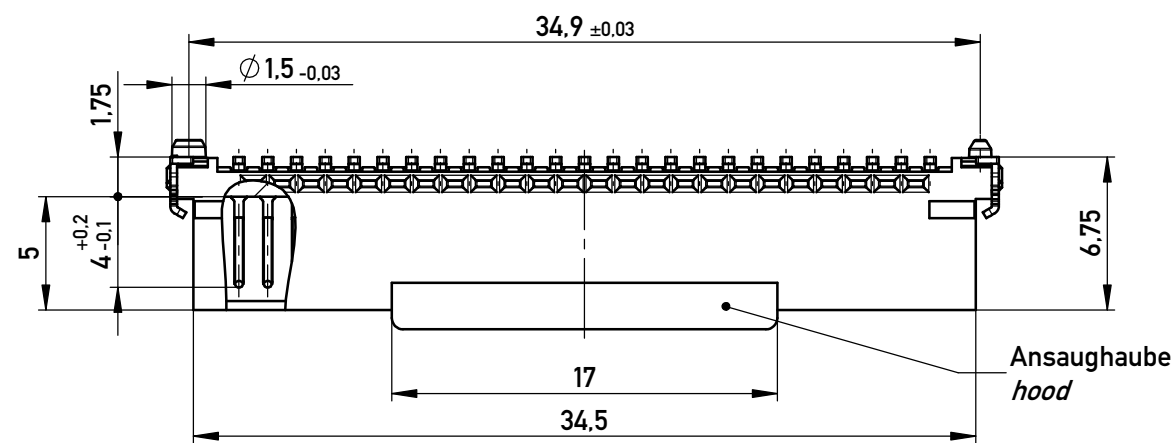
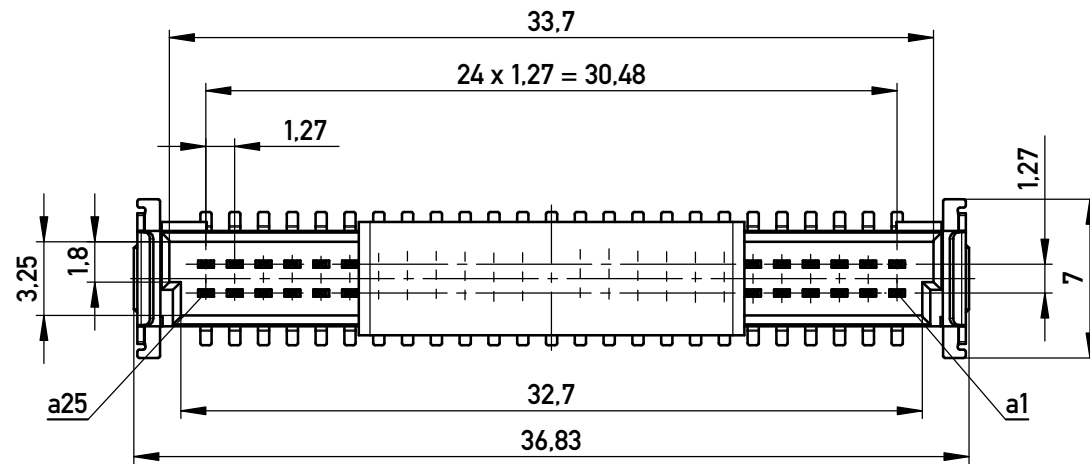
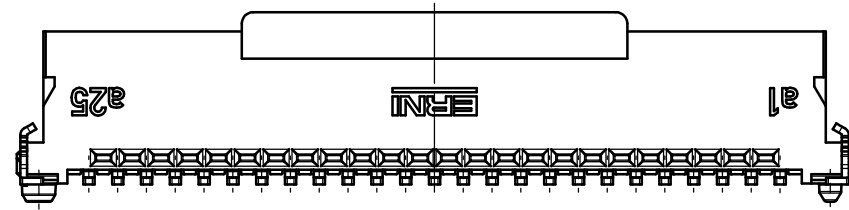
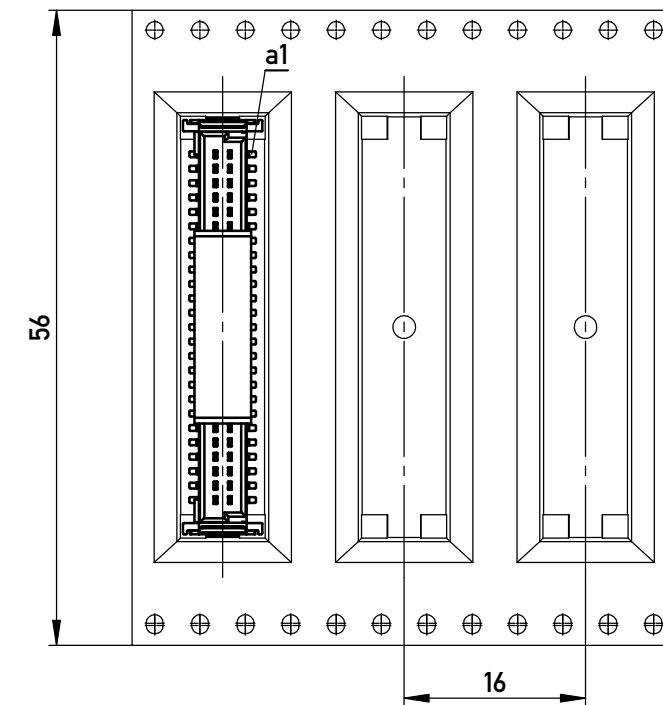

Leiterplatten-Layout Vorschlag für SMT
 PCB-Layout Proposal for SMT

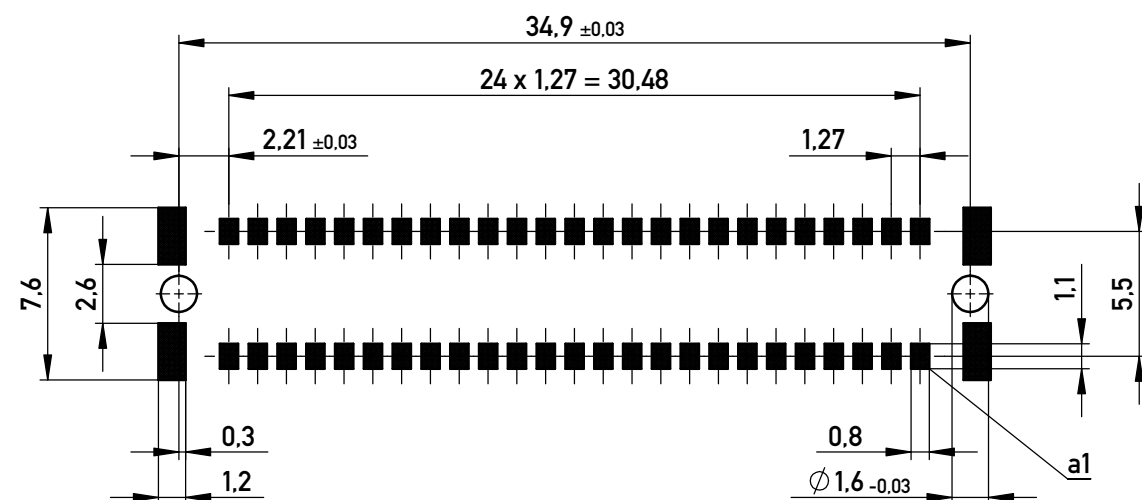

BA 8-13 - 8mm Bauhöhe
 type 8-13 - Low Profile

Information:		Tolerances	 All Dimensions in mm	Scale	3:1
All rights reserved. Only for Information. To ensure that this is the latest version of this drawing, please contact one of the ERNI companies before using.		Subject to modification without prior notice. Drawing will not be updated.		Designation Messertl. SMC-Q 50-SMD-BA8-13 Male SMC-Q 50-SMD-type 8-13	
Copyright by ERNI GmbH Proprietary notice pursuant to ISO 16016 to be observed.		www.ERNI.com		100403210072	
e	30.06.2015				
Index	Date			Class SMCQ	
				K A3	